



TRANSIT™ LITTER & RECYCLING RECEPTACLE

PRODUCT DATA





TRANSIT™ LITTER & RECYCLING RECEPTACLE

PRODUCT DATA

The Transit Litter & Recycling Receptacle provides an attractive and efficient all-in-one solution for public space litter and recycling collection. Made from durable, corrosion-resistant stainless steel, Transit's space-saving design incorporates dual- or tri-stream openings and independent internal liners for different waste streams. Large side-access doors and a quick-action latch make Transit exceptionally easy to service. Available in a range of high-performance stainless steel finishes, Transit is ideal for airports, transit terminals, university campuses, and other environments where ruggedness, maintenance ease, and efficient use of space are priorities.

MATERIAL & CONSTRUCTION DETAILS

INSTALLATION & MAINTENANCE

CONFIGURATION OPTIONS	LID CONSTRUCTION & OPENINGS	OPTIONAL RAIN COVER	INSTALLATION
<ul style="list-style-type: none"> The receptacle is available in dual-stream and tri-stream top-opening configurations and has a 60-gallon capacity. Dual-stream receptacles use a 20-gallon and 40-gallon liner. Tri-stream receptacles use three 20-gallon liners. 	<ul style="list-style-type: none"> Lids are available with dual-stream or tri-stream openings. Dual-stream lids of cast aluminum or molded polyethylene have large and small rectangular openings. Tri-stream lids are available in multiple configurations. Options include cast aluminum lids with three similarly sized rectangular openings; or cast aluminum or molded polyethylene lids with waste-specific openings: a square opening for litter, and oval slot for paper, and a round opening for bottles and cans. 	<ul style="list-style-type: none"> Rain covers are only available for use with cast aluminum lids. Made from heavy corrosion-resistant cast aluminum, the optional rain cover is supported by tubular aluminum mounting posts. Rain cover is powdercoated to match lid. 	<ul style="list-style-type: none"> Receptacles can be used freestanding or surface mounted. Levelers are supplied for all units. For surface mounting, stainless steel anchors and mounting bolts sold separately.
BODY & FRAME	LID FINISHES & GRAPHICS	SIDE ACCESS DOORS & LINER	MAINTENANCE
<ul style="list-style-type: none"> Stainless steel body comes standard in Sandstone, Linen, Diamond, and Satin finishes. Structural frame consists of corrosion-resistant solid cast aluminum base and top with stainless steel vertical supports. 	<ul style="list-style-type: none"> Molded polyethylene lids have a lightly textured surface and are available in black, blue, and green. Cast aluminum lids have a powdercoat finish. See the Forms+Surfaces Powdercoat Chart for details. Custom RAL colors are available for an upcharge. Instructional graphics are located on both sides of the lid with black, blue, and green backgrounds and white messages and symbols, clearly indicating the use for each opening. Graphics are printed on the back of clear, lightly textured polycarbonate, protecting them from wear over time. 	<ul style="list-style-type: none"> A pair of asymmetrical swing-out doors allows easy access to internal liners. Finish matches the body. Transit's stainless steel quick-action latch allows for reliable and simple operation. Transit uses independent, replaceable internal liners designed to be used with or without plastic litter bags. Liners are molded from durable black polyethylene with a UL94HB fire rating. 	<ul style="list-style-type: none"> Metal surfaces can be cleaned as needed using a soft cloth or brush with warm water and a mild detergent. Avoid abrasive cleaners.

NOMINAL DIMENSIONS

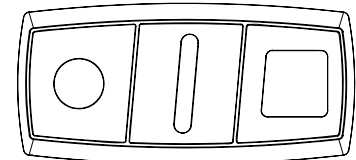
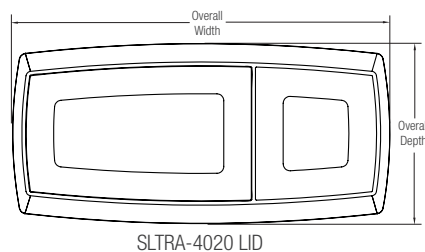
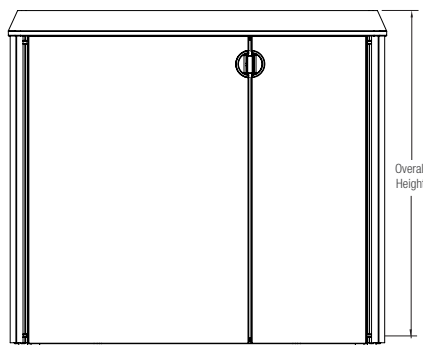

SLTRA-180 LID

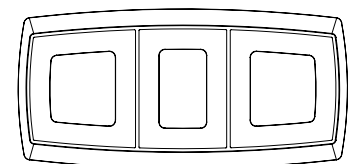

SLTRA-320 LID

MODEL	OVERALL HEIGHT	OVERALL WIDTH	OVERALL DEPTH	OVERALL WEIGHT	CAPACITY
SLTRA-4020 with polyethylene lid	35.9" (912 mm)	40.8" (1036 mm)	19.5" (495 mm)	117 lbs (53 kg)	60 gal. (1) 40 gal. and (1) 20 gal. liner (227 liters)
SLTRA-4020 with cast aluminum lid	35.9" (912 mm)	40.8" (1036 mm)	19.5" (495 mm)	128 lbs (58 kg)	60 gal. (1) 40 gal. and (1) 20 gal. liner (227 liters)
SLTRA-180 with polyethylene lid	35.9" (912 mm)	40.8" (1036 mm)	19.5" (495 mm)	117 lbs (53 kg)	60 gal. (3 x 20) gallons (227 liters)
SLTRA-180 with cast aluminum lid	35.9" (912 mm)	40.8" (1036 mm)	19.5" (495 mm)	128 lbs (58 kg)	60 gal. (3 x 20) gallons (227 liters)
SLTRA-320 with cast aluminum lid	35.9" (912 mm)	40.8" (1036 mm)	19.5" (495 mm)	128 lbs (58 kg)	60 gal. (3 x 20) gallons (227 liters)

T 800.451.0410 | www.forms-surfaces.com

FORMS+SURFACES®

© 2021 Forms+Surfaces® | All dimensions are nominal. Specifications and pricing subject to change without notice. For the most current version of this document, please refer to our website at www.forms-surfaces.com



TRANSIT™ LITTER & RECYCLING RECEPTACLE

PRODUCT DATA

NOMINAL DIMENSIONS (CONTINUED)

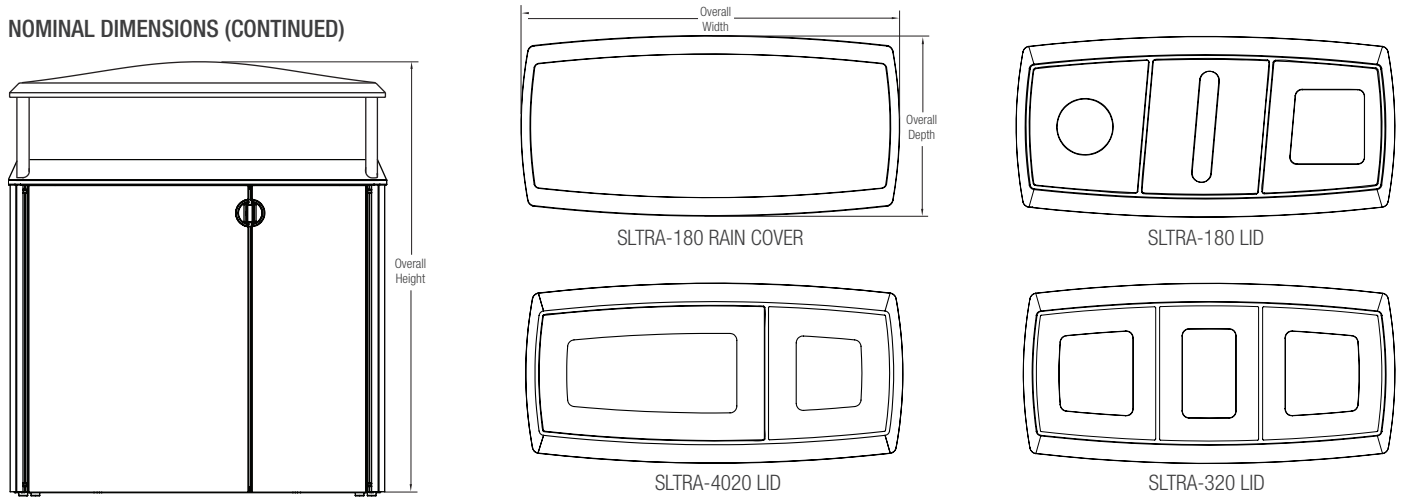

MODEL	OVERALL HEIGHT	OVERALL WIDTH	OVERALL DEPTH	OVERALL WEIGHT	CAPACITY
SLTRA-4020 with cast aluminum lid & rain cover	46.5" (1181 mm)	40.8" (1036 mm)	19.5" (495 mm)	131 lbs (59.4 kg)	60 gal. (1) 40 gal. and (1) 20 gal. liner (227 liters)
SLTRA-180 with cast aluminum lid & rain cover	46.5" (1181 mm)	40.8" (1036 mm)	19.5" (495 mm)	142 lbs (64.4 kg)	60 gal. (3 x 20) gallons (227 liters)
SLTRA-320 with cast aluminum lid & rain cover	46.5" (1181 mm)	40.8" (1036 mm)	19.5" (495 mm)	142 lbs (64.4 kg)	60 gal. (3 x 20) gallons (227 liters)

LID OPENINGS

MODEL	SLTRA-4020 LID
TOP VIEW	
OPENINGS	Large opening: 18.4" x 8.6" (467 mm x 218 mm) Small opening: 7.1" x 8.1" (180 mm x 206 mm)

MODEL	SLTRA-180 LID	SLTRA-320 LID
TOP VIEW		
OPENINGS	Round opening (bottles & cans): 6.0" (152 mm) Oval slot (paper): 2.0" x 12.0" (51 mm x 305 mm) Square opening (litter): 8.0" x 8.0" (203 mm x 203 mm)	Center opening: 6.0" x 9.6" (152 mm x 244mm) Side openings: 8.1" x 8.7" (206 mm x 221 mm)

T 800.451.0410 | www.forms-surfaces.com

FORMS+SURFACES®

© 2021 Forms+Surfaces® | All dimensions are nominal. Specifications and pricing subject to change without notice. For the most current version of this document, please refer to our website at www.forms-surfaces.com



TRANSIT™ LITTER & RECYCLING RECEPTACLE

PRODUCT DATA

POLYETHYLENE LID COLORS



BLACK

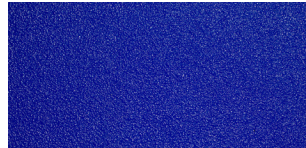

BLUE



GREEN

STANDARD GRAPHICS

Graphics have black, blue, and green backgrounds to clearly indicate each opening's use, as shown below. All messages and symbols are white.

MODEL SLTRA-4020 EXAMPLES

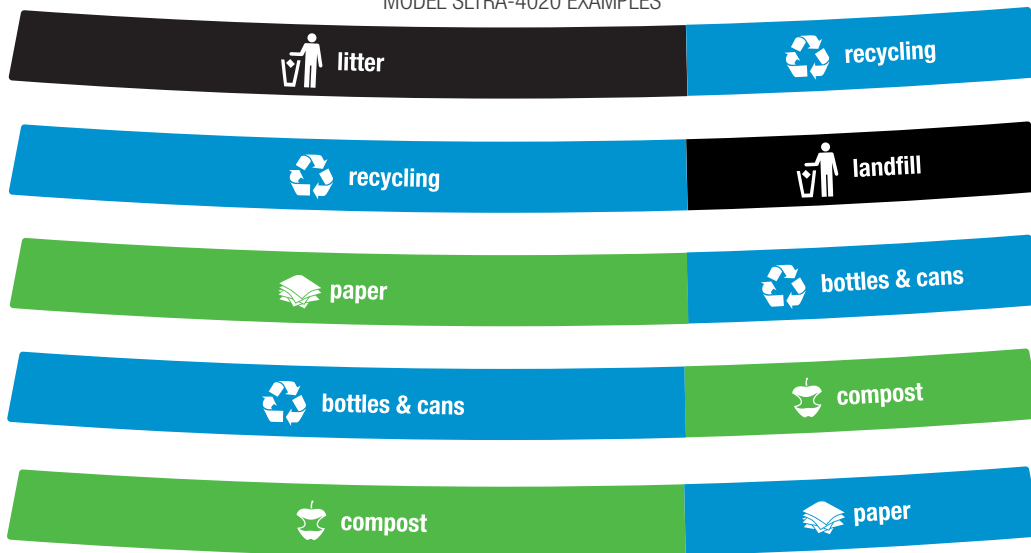

MODEL SLTRA-180



MODEL SLTRA-320 EXAMPLES



NOTE: Blue and green background colors are not intended to match blue and green lid colors. Graphics with black backgrounds are recommended when selecting blue or green lids.



TRANSIT™ LITTER & RECYCLING RECEPTACLE

PRODUCT DATA

ENVIRONMENTAL CONSIDERATIONS

- Please refer to the Transit Receptacle Environmental Data Sheet for detailed environmental impact information.
- Transit has up to 69% recycled content.
- All components are fully recyclable.
- Stainless steel construction ensures a long product life cycle.
- Standard powdercoat finishes are no-VOC; non-standard powdercoat finishes are no- or low-VOC, depending on color.
- Low maintenance.

MODEL NUMBERS AND DESCRIPTIONS

MODEL	DESCRIPTION
SLTRA-4020	Transit Litter & Recycling Receptacle, dual-stream, with polyethylene lid
SLTRA-4020	Transit Litter & Recycling Receptacle, dual-stream, with cast aluminum lid
SLTRA-180	Transit Litter & Recycling Receptacle, tri-stream, polyethylene lid with waste-specific openings
SLTRA-180	Transit Litter & Recycling Receptacle, tri-stream, cast aluminum lid with waste-specific openings
SLTRA-320	Transit Litter & Recycling Receptacle, tri-stream, cast aluminum lid with rectangular openings

PRODUCT OPTIONS

The following options are available for an upcharge

Add cast aluminum rain cover (requires cast aluminum lid)	Custom RAL powdercoat color (for cast aluminum lid)
Add stainless steel mounting hardware	

LEAD TIME: 6 to 8 weeks. Shorter lead times may be available upon request. Please contact us to discuss your specific timing requirements.

PRICING: Please contact us at **800.451.0410** or **sales@forms-surfaces.com**. At Forms+Surfaces, we design, manufacture and sell our products directly to you. Our sales team is available to assist you with questions about our products, requests for quotes, and orders. Territory Managers are located worldwide to assist with the front-end specification and quoting process, and our in-house Project Sales Coordinators follow your project through from the time you place an order to shipment.

TO ORDER SPECIFY: Quantity, model, stainless steel finish, polyethylene lid color or cast aluminum lid powdercoat color, lid graphics, liner with or without drain holes, freestanding or surface mount. Quote/Order Forms are available on our website to lead you through the specification process in a simple checkbox format.

NOTE: Because different computers will render colors and textures differently, actual colors and finishes may vary from those shown here.