













TENZA™ CHARGING STATION

53" SURFACE MOUNT INSTALLATION INSTRUCTIONS

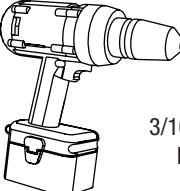
MOUNTING KIT (SOLD SEPARATELY)		TOOLS NEEDED		
 a  b  c  d  e	 7/32" hex bit for tamper-resistant bolts  epoxy	 T30 tamper-resistant torx bit  pencil	 hammer drill  3/16", 3/8" & 1/2" drill bits for concrete	 steel wire brush  1/4" punch  hammer

STEP BY STEP FOR ALL 53" TENZA CHARGING STATIONS

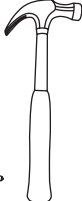
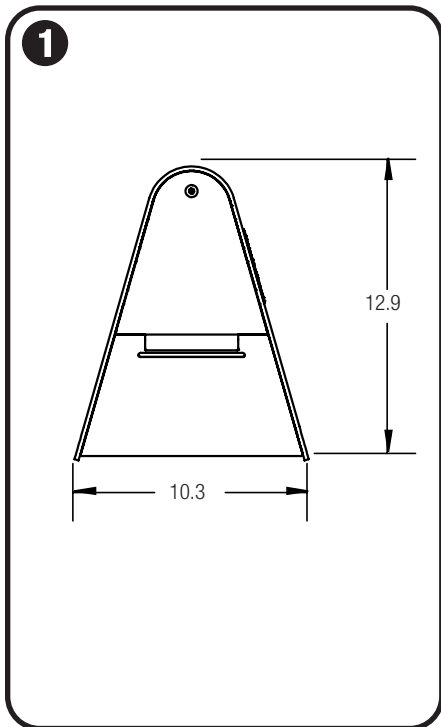

Mark hole locations

- Place template in desired location. Mark center of each hole location (four total) with a pencil.

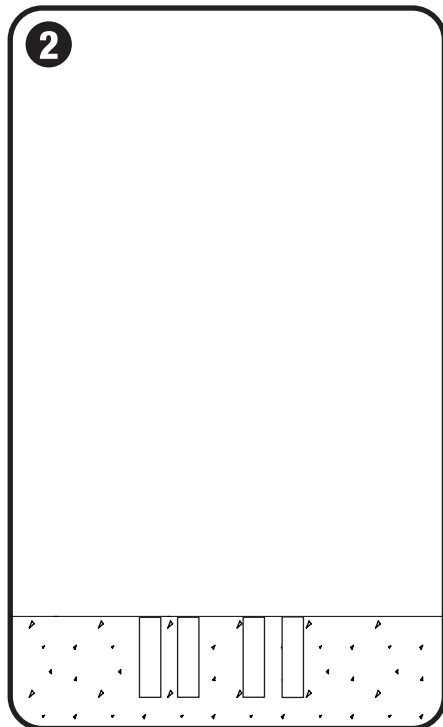

Drill holes

- Use hammer drill to drill 4.5" deep x 3/4" diameter anchor holes at each marked location using a 3/4" drill bit suitable for concrete drilling.
- NOTE: Forms+Surfaces recommends starting holes with 1/4" diameter drill bit followed by 1/2" and finally 3/4" for maximum accuracy.

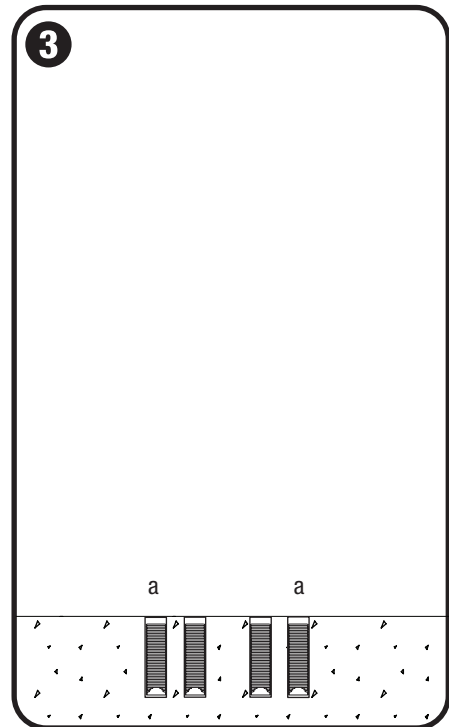

Fill holes & insert anchors

- Use compressed air and steel wire brush to clean each anchor hole in accordance with epoxy instructions.
- Use epoxy in epoxy gun to fill each anchor hole 5/8" of the hole depth in accordance with epoxy instructions.
- Insert 3/8"-16 x 4-1/4" epoxy anchor (a) into each anchor hole so anchor top is flush with ground. Allow proper curing time according to cure schedule on epoxy instructions before moving on to step 4.

TENZA™ CHARGING STATION

53" SURFACE MOUNT INSTALLATION INSTRUCTIONS

STEP BY STEP FOR ALL 53" TENZA CHARGING STATIONS

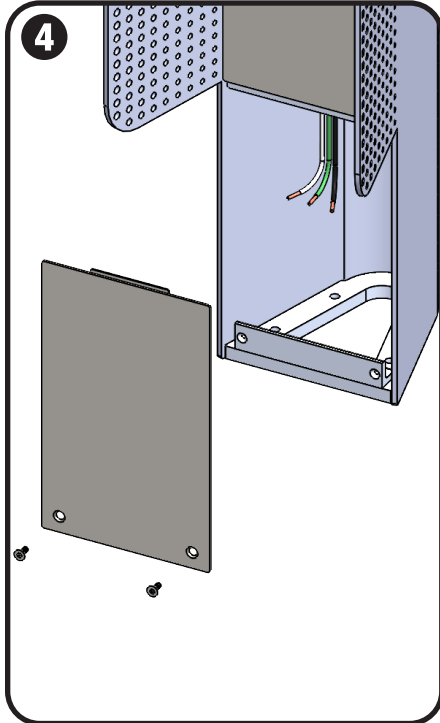

Locate wires

Note: Installation should be performed only by qualified individuals.

- Before proceeding with wiring of fixture, check to ensure that all applicable site wiring and safety codes have been followed.
- Remove two bolts on access door at base of charging station with T30 security torx bit, and remove access door.
- Locate wires at base of charging station. Ensure power supply is shut off and circuit being used is isolated.

Caution: Installation of a surge protector as part of each unit's wiring is recommended.

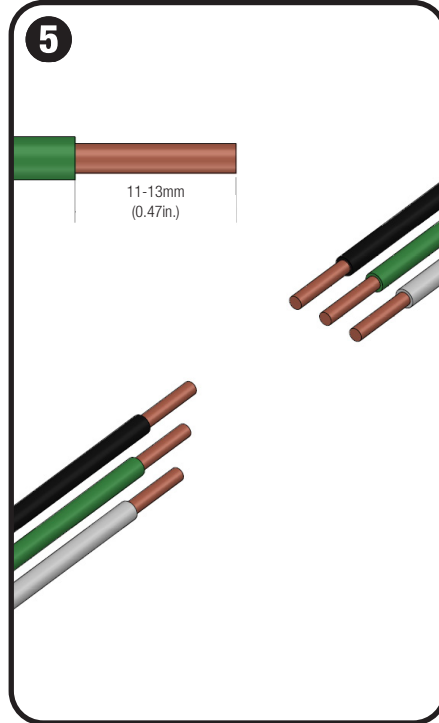

Prepare wires

- Prepare wiring from site junction box and charging station by stripping and removing 11-13mm (.47") of insulation.

Note: Wire used should be 12-14 AWG copper conductors.

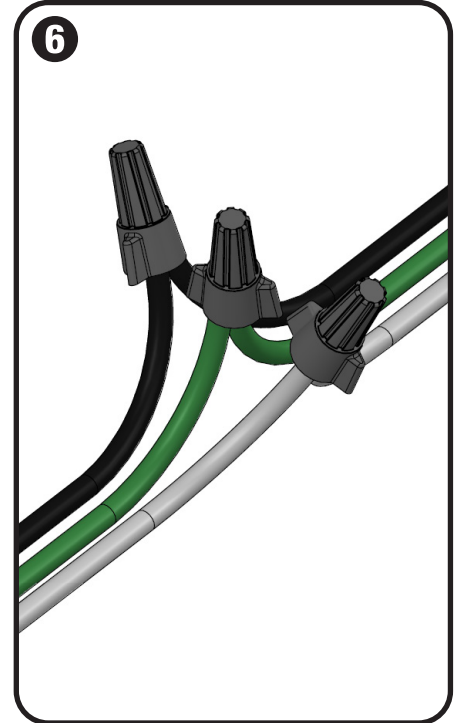

Connect wires

- Insert ground (green), neutral (white), and positive (black) wires into wire nuts, being sure to match wire color codes from junction box to fixture.
- Tighten wire nuts until exposed wire ends are below bottom of wire nut.
- Inspect all wiring and connections before turning power supply on.

Caution: Charging station rated for 120 VAC power.

TENZA™ CHARGING STATION

53" SURFACE MOUNT INSTALLATION INSTRUCTIONS

STEP BY STEP FOR ALL 53" TENZA CHARGING STATIONS

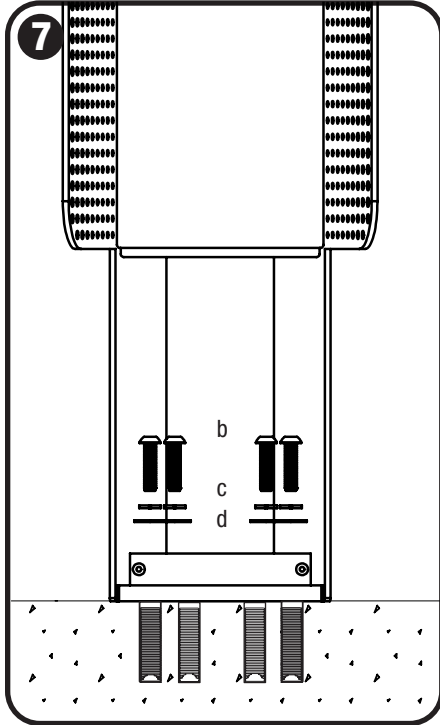

Position & attach charging station

- Position charging station so that mounting holes line up with anchors.
- Slide 3/8" stainless steel lock washer (c), and 3/8" stainless steel flat washer (d), onto each 3/8"-16 x 1.5" tamper-resistant button head cap bolt (b).
- Insert bolts into mounting holes in the bollard's base plate and thread into anchors using 7/32" hex bit for tamper-resistant bolts.
- Tighten bolts until snug.

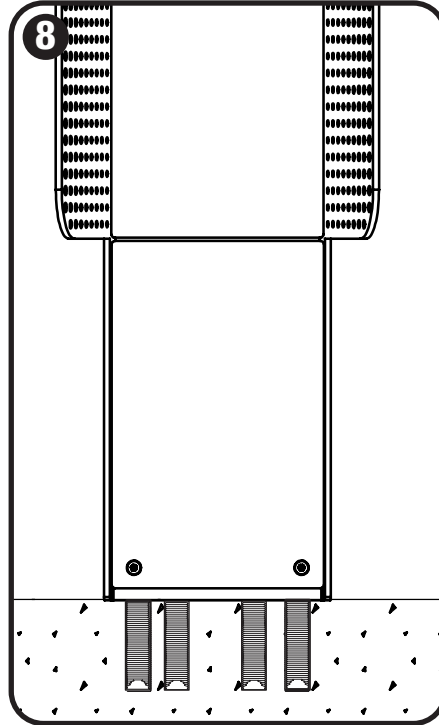

Reinstall bottom access door

- Align access door with charging station body.
- Insert access door bolts that were removed in step 4 using T30 security hex bit. Tighten until snug.