

AVIVO™ BAR TABLE

SURFACE MOUNT INSTALLATION INSTRUCTIONS

MOUNTING KIT (SOLD SEPARATELY)

7/32" hex bit for tamper-resistant bolts

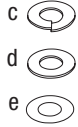

TOOLS NEEDED



pencil



steel wire brush



1/4" & 1/2" drill bits for concrete

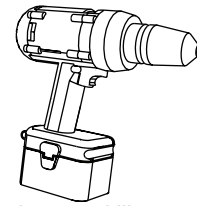

hammer drill

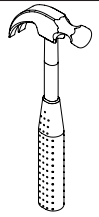

hammer

STEP BY STEP FOR ALL SURFACE MOUNT AVIVO BAR TABLES

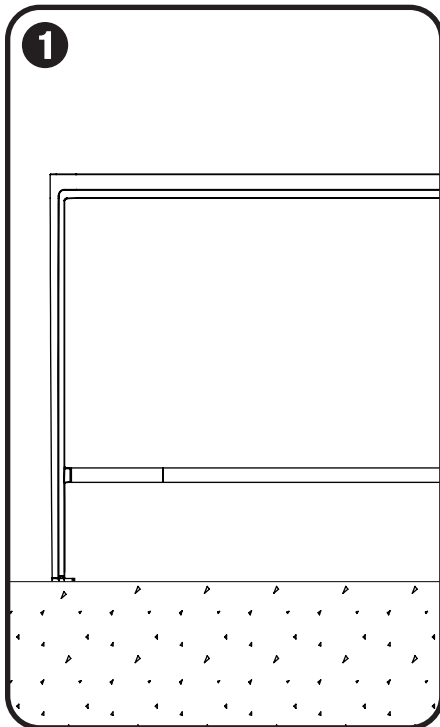

Mark hole locations

- Place table in desired location. Mark the center of each mounting hole location with a pencil.

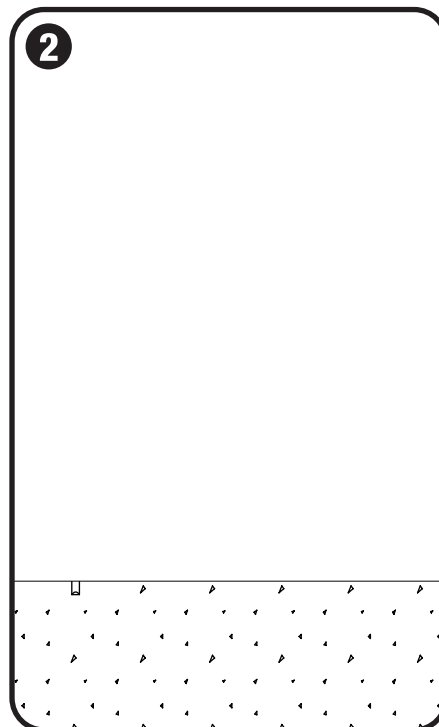

Drill holes

- Use hammer drill to drill 1.5" deep x 1/2" diameter anchor hole at each marked location using a 1/2" drill bit suitable for concrete drilling.

NOTE: Forms+Surfaces recommends starting holes with 1/4" diameter drill bit followed by 1/2" for maximum accuracy.

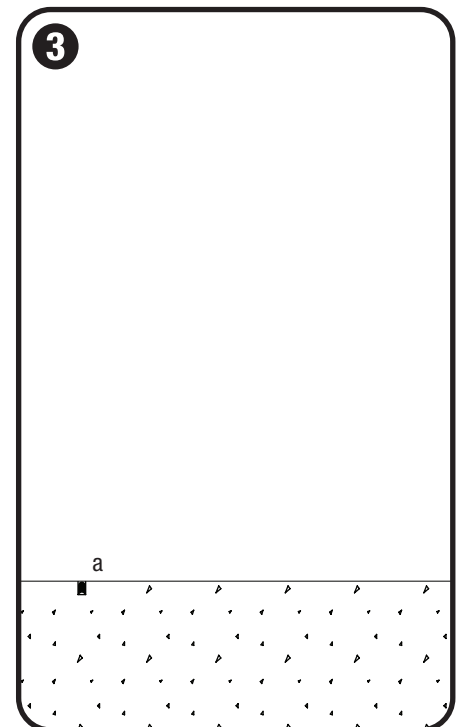

Fill holes & insert anchors

- Use compressed air and steel wire brush to clean each anchor hole.
- Insert 3/8"-13 x 1-1/2" anchor (a) into each anchor hole. Using a hammer, make sure anchor top is flush with ground.

AVIVO™ BAR TABLE

SURFACE MOUNT INSTALLATION INSTRUCTIONS

STEP BY STEP FOR ALL SURFACE MOUNT AVIVO BAR TABLES

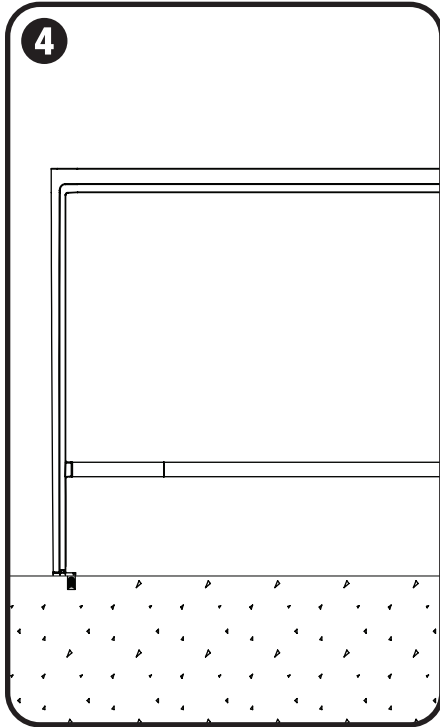

Position table

- Position table so that mounting holes line up with anchors.

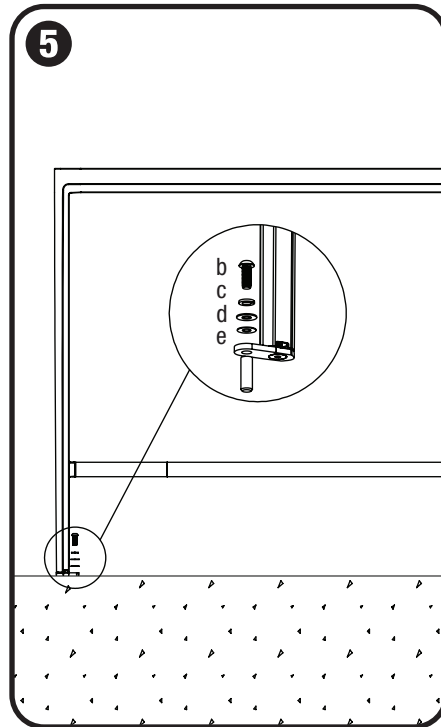

Attach table

- Slide 3/8" stainless steel lock washer (c), 3/8" stainless steel flat washer (d), and 3/8" PFTE washer (e) onto each 3/8"-16 x 1" tamper-resistant button head cap bolt (b).
- Insert bolts into mounting holes in table and thread into anchors using 7/32" hex bit for tamper-resistant bolts.

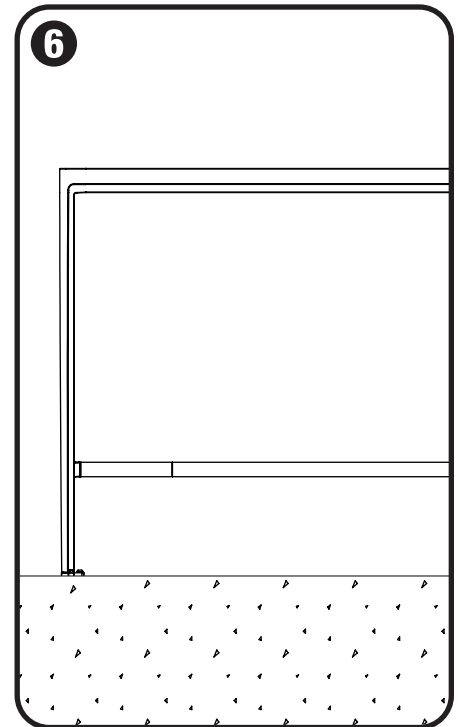

Tighten bolts

- Tighten bolts until snug.