



# LIGHT COLUMN PEDESTRIAN

PRODUCT DATA





# LIGHT COLUMN PEDESTRIAN

PRODUCT DATA

Sleek in stainless steel, **Light Column Pedestrian Lighting** integrates into a wide range of settings and offers numerous design possibilities. Fixtures are available in 5" or 6" diameters. Illumination options include LED lamping and multiple ways to direct light: no shield for symmetrical lighting, or 180° and 360° shields in standard or custom designs. Coordinating Light Column Pathway Bollards and Light Column Bollards in illuminated, RGBW, non-illuminated, and security core variations make it easy to create a cohesive look across functionalities.

## MATERIAL & CONSTRUCTION DETAILS

CONFIGURATIONS	MATERIALS & FINISHES	LED LAMPS & DRIVERS
<ul style="list-style-type: none"> <li>Light Column Pedestrians are available in two sizes. Series 500 columns use 5" (127 mm) diameter tubular stainless steel; Series 600 columns use 6" (152 mm) diameter tubular stainless steel.</li> <li>Heads consist of a white-frosted acrylic lens and stainless steel head cap.</li> <li>Weather resistant GFCI outlet for maintenance access is available for Series 600 pedestrians. See drawings on our website for details.</li> <li>Door for optional GFCI outlet is accessed using a flathead screwdriver.</li> </ul>	<ul style="list-style-type: none"> <li>Standard stainless steel finish is Satin with Ceramiloc treatment. See below for details</li> <li>For optional powdercoat colors see the Forms+Surfaces Powdercoat Chart. Custom RAL colors are available for an upcharge.</li> </ul>	<ul style="list-style-type: none"> <li>Custom LED light engine with Cree® LEDs.</li> <li>Features advanced LED technology with 32W, 3000K warm white and 4000K natural white LEDs.</li> <li>LED driver input power is 90-305V.</li> <li>Driver has 0-10V dimming capabilities.</li> <li>LED driver certifications include: IP67 (waterproof) enclosure, and Class 2 rated output.</li> </ul>
WEIGHT	SHIELD OPTIONS	
<ul style="list-style-type: none"> <li>Series 500: 65 lbs (29 kg)</li> <li>Series 600: 75 lbs (34 kg)</li> </ul>	<ul style="list-style-type: none"> <li>Six standard shield designs are available for an upcharge. Refer to pages 3 and 4 for details.</li> <li>Custom shield designs with either 180° or 360° coverage are also available.</li> </ul>	

## CERAMILOC TREATMENT

Ceramiloc is an invisible surface treatment that offers significantly enhanced protection from weather and graffiti and increases the maintenance ease of stainless steel. Ceramiloc combines ceramic durability with an unparalleled ability to lock out water spots, fingerprints, graffiti and more. Patented technology bonds nano-silica particles to the surface of the stainless steel. The treatment minimally alters the surface appearance of the stainless and offers numerous benefits:

- Easily Cleaned:** The Ceramiloc treatment creates a surface that simultaneously resists fingerprints and is easy to clean. Water spots, grease marks and more can be quickly wiped away. It also creates an "anti-graffiti" surface – even permanent marker is easily removed with a clean microfiber towel and water.
- Durable:** Ceramiloc-treated materials are abrasion- and scratch-resistant. The treatment is permanent, UV stable, and will not degrade or discolor over time.
- Environmentally Sound:** The Ceramiloc treatment is a no-VOC, water-based process. Because Ceramiloc surfaces are so easily maintained, cleaning solutions and maintenance are kept to a minimum.

## INSTALLATION & MAINTENANCE

INSTALLATION	MAINTENANCE
<ul style="list-style-type: none"> <li>Standard mounting is 1/2" stainless steel base plate with cover. Base plate is slotted for rotational capability.</li> <li>Installation of a surge protector as part of each units wiring is recommended.</li> <li>Stainless steel mounting hardware sold separately. Template is available upon request.</li> </ul>	<ul style="list-style-type: none"> <li>Metal surfaces can be cleaned as needed using a soft cloth or brush with warm water and a mild detergent. Avoid abrasive cleaners.</li> </ul>



# LIGHT COLUMN PEDESTRIAN

PRODUCT DATA

## NOMINAL DIMENSIONS

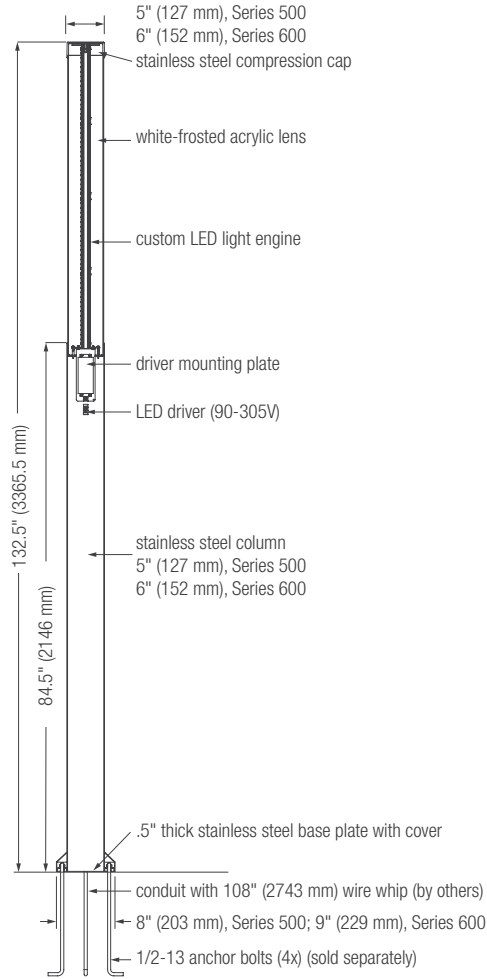

BASE PLATE MOUNTING DETAIL (SERIES 500)

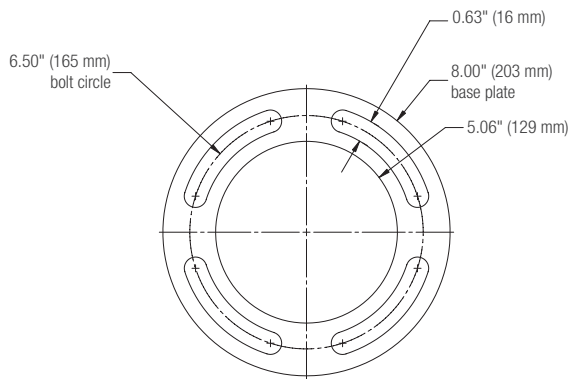

BASE PLATE MOUNTING DETAIL (SERIES 600)

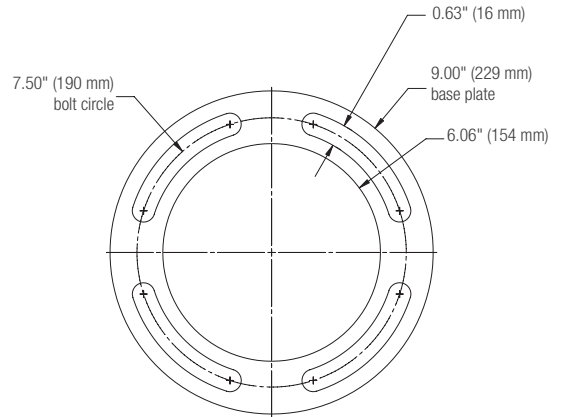



**STANDARD SHIELD DESIGNS**

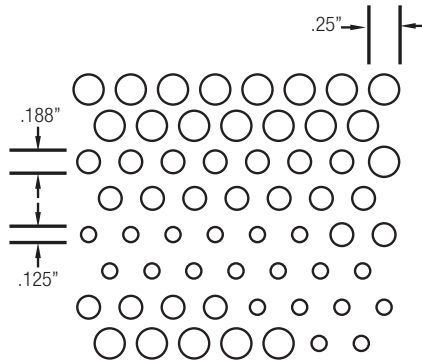
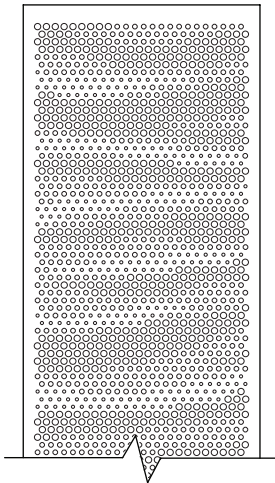
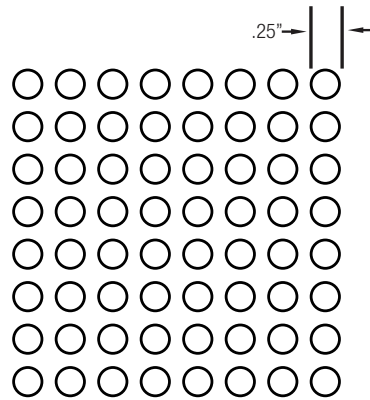
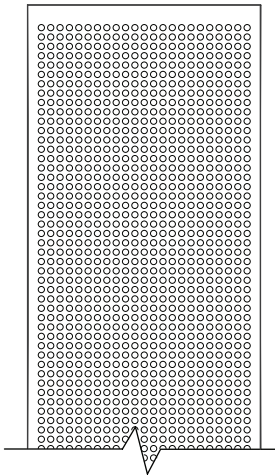
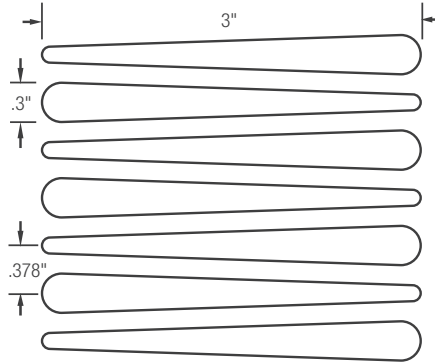
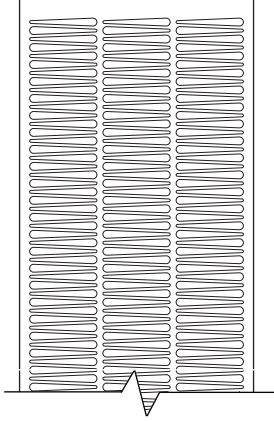

**KENTE**

	Series 500	Series 600
180 Pedestrian	N/A	•
360 Pedestrian	N/A	N/A
180 Bollard	N/A	•
360 Bollard	N/A	N/A

**PERFORATED**

	Series 500	Series 600
180 Pedestrian	•	•
360 Pedestrian	•	•
180 Bollard	•	•
360 Bollard	•	•

**SCAPE**

	Series 500	Series 600
180 Pedestrian	•	•
360 Pedestrian	•	•
180 Bollard	•	•
360 Bollard	•	•

NOTE: "•" indicates that the shield design is available in the selected series and size combination



STANDARD SHIELD DESIGNS (CONTINUED)

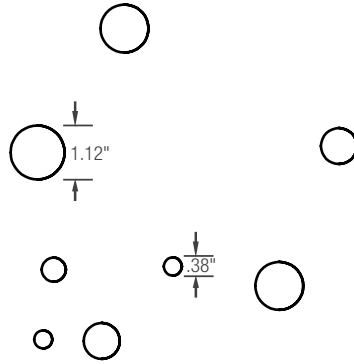
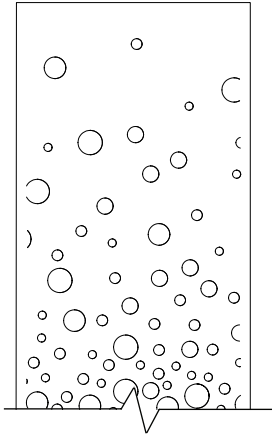

**BUBBLES**

	Series 500	Series 600
180 Pedestrian	•	•
360 Pedestrian	•	•
180 Bollard	•	•
360 Bollard	•	•

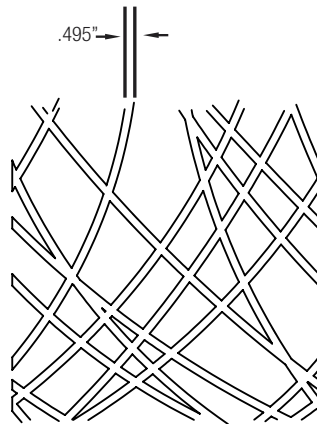
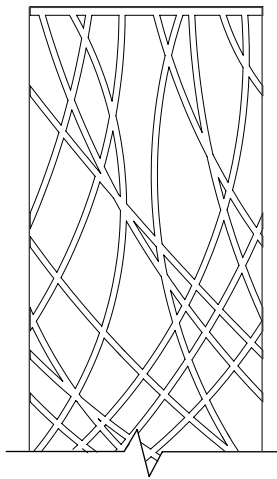

**RIBBON**

	Series 500	Series 600
180 Pedestrian	N/A	N/A
360 Pedestrian	•	•
180 Bollard	N/A	N/A
360 Bollard	N/A	N/A

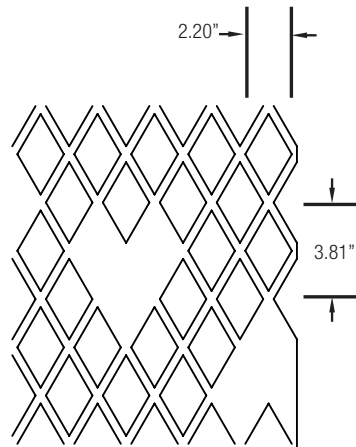
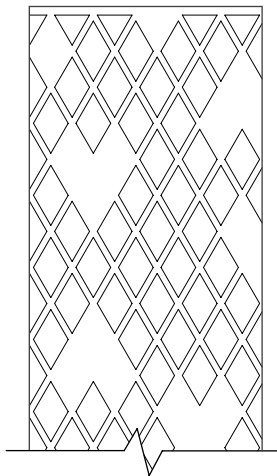

**ARGYLE**

	Series 500	Series 600
180 Pedestrian	N/A	N/A
360 Pedestrian	•	•
180 Bollard	N/A	N/A
360 Bollard	N/A	N/A

NOTE: "•" indicates that the shield design is available in the selected series and size combination



# LIGHT COLUMN PEDESTRIAN

PRODUCT DATA

## LAMP DESCRIPTIONS

LAMP	DESCRIPTION	LUMINAIRE LUMENS*		B.U.G. RATING	STARTING TEMPERATURE °C
		500	600		
3000K LED	32W custom LED light engine	3783	3790	B1-U5-G2	-30
4000K LED	32W custom LED light engine	3783	3790	B1-U5-G2	-30

\*Luminaire lumens represents the absolute photometry for the luminaire, and indicates the lumens out of the entire fixture.

**NOTE: Polar candela and isofootcandle plots can be found on the Light Column Pedestrian product page on our website.**

## CERTIFICATION

- ETL and C-ETL listed for wet locations

## ENVIRONMENTAL CONSIDERATIONS

- Please refer to the Light Column Pedestrian Environmental Data Sheet for detailed environmental impact information.
- Light Column Pedestrian has high recycled content and is highly recyclable.
- Powdercoat finishes are no- or low-VOC, depending on color.
- Low maintenance.

## MODEL NUMBERS AND DESCRIPTIONS

MODEL	DESCRIPTION
LPLCO-512	Light Column Pedestrian, Series 500
LPLCO-612	Light Column Pedestrian, Series 600

## PRODUCT OPTIONS

The following options are available for an upcharge

Add 180° perforated shield in standard designs	GFCI outlet (available for Series 600 pedestrian)
Add 360° perforated shield in standard designs	Add powdercoat color from Forms+Surfaces Powdercoat Chart
Add 180° custom shield (customer supplied artwork)	Custom RAL powdercoat color
Add 360° custom shield (customer supplied artwork)	Custom fixture height
Add stainless steel mounting hardware	

**LEAD TIME:** 6 to 8 weeks. Shorter lead times may be available upon request. Please contact us to discuss your specific timing requirements.

**PRICING:** Please contact us at **800.451.0410** or **sales@forms-surfaces.com**. At Forms+Surfaces, we design, manufacture and sell our products directly to you. Our sales team is available to assist you with questions about our products, requests for quotes, and orders. Territory Managers are located worldwide to assist with the front-end specification and quoting process, and our in-house Project Sales Coordinators follow your project through from the time you place an order to shipment.

**TO ORDER SPECIFY:** Quantity, model, finish, lamp, shield (if applicable). Quote/Order Forms are available on our website to lead you through the specification process in a simple checkbox format.

NOTE: Because different computers will render colors and textures differently, actual colors and finishes may vary slightly from those shown here.